

技术参数：  
 - 材料：压铸铝  
 - 表面处理：粉末喷涂  
 - 颜色：Grey（灰色）  
 - 温度范围：-40℃ - +125℃  
 - 防护等级：IP65（联锁状态，IEC 60529）  
 - 出线方向：顶出线  
 - 出线孔数：1  
 - 螺纹规格：M25

Technical specification:  
 - Material: Aluminium die-cast  
 - Surface: powder-coated  
 - Colour: (grey)  
 - Temperature range:  
     -40℃ - +125℃  
 - Degree of Protection: IP65  
   (acc.to IEC 60529 for coupled connector)  
 - Cable entry: top entry  
 - No. of cable entries: 1  
 - Thread size: M25

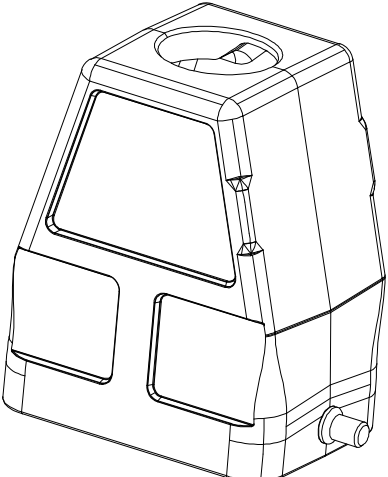

<b>ZJKK</b> 浙江昊科电气有限公司 ZHEJIANG HAOKE ELECTRICAL CO.,LTD		图号 Drawing No:		/			
产品代号 Part Code: H6B-TEH-2B-M25		产品料号 PART NO: 19300060446					
Date:	2018.08.10	Scale	REV	Weight	Qty	Drawn:	SHEET
	All Dimensions in mm Original Size DIN A 4	1:1	HK-1	/	/	Tang	1/1